



1000W Slim Type with PFC Switching Supply

**UHP-1000** series



### ■ Features

- Slim and Low profile (41mm)
- Fanless and conduction-cooled design
- Withstand 300VAC surge input for 5 seconds
- Built-in active PFC function
- -30~+70°C working temperature
- Output voltage and constant current level programmable
- Protections: Short circuit / Overload / Over voltage / Over temperature
- Built-in remote ON-OFF control
- DC OK active signal
- Operating altitude up to 5000 meter (Note.7)
- LED indicator for power on
- 5 years warranty

### ■ Applications

- Industrial automation machinery
- Industrial control system
- Mechanical and electrical equipment
- Electronic instruments, equipment or apparatus
- Test and measurement instrument
- Laser related machine
- Charging related equipment
- Household appliances
- Power Sourcing Equipment of PoE (48V model: DC O/P range 48~57.6V)

### ■ GTIN CODE

MW Search: <https://www.meanwell.com/serviceGTIN.aspx>

### ■ Description

UHP-1000 series is a 1000W single-output slim type power supply with 41mm of low profile design. Adopting the full range 90~264VAC input, the entire series provides an output voltage line of 12V,24V,36V and 48V. In addition to the high efficiency up to 96%, that the whole series operates from -30°C ~ 70°C under air convection without fan. UHP-1000 has the complete protection functions and 5G anti-vibration capability; It is complied with the international safety regulations such as TUV BS EN/EN62368-1, UL62368-1. UHP-1000 series serves as a high performance power supply solution for various industrial applications.

### ■ Model Encoding

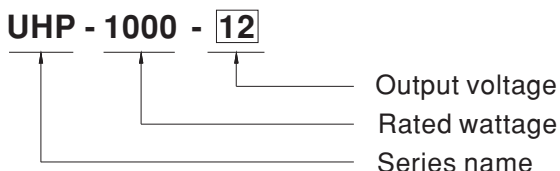

## SPECIFICATION

MODEL		UHP-1000-12	UHP-1000-24	UHP-1000-36	UHP-1000-48	
OUTPUT	DC VOLTAGE	12V	24V	36V	48V	
	RATED CURRENT	80A	42A	28A	21A	
	RATED POWER	960W	1008W	1008W	1008W	
	RIPPLE & NOISE (max.) Note.2	150mVp-p	240mVp-p	240mVp-p	300mVp-p	
	VOLTAGE ADJ. RANGE	By built-in potentiometer, SVR				
		12~14.4V	24~28.8V	36~43.2V	48~57.6V	
	VOLTAGE TOLERANCE Note.3	±1.0%	±1.0%	±1.0%	±1.0%	
	LINE REGULATION	±0.5%	±0.5%	±0.5%	±0.5%	
	LOAD REGULATION	±0.5%	±0.5%	±0.5%	±0.5%	
SETUP, RISE TIME Note.4	1000ms, 50ms/230VAC 1000ms, 50ms/115VAC at full load					
HOLD UP TIME (Typ.)	12ms/230VAC	12ms/115VAC				
INPUT	VOLTAGE RANGE Note.4	90 ~ 264VAC 250 ~ 370VDC				
	FREQUENCY RANGE	47 ~ 63Hz				
	POWER FACTOR (Typ.) Note.4	PF ≥ 0.95/230VAC PF ≥ 0.99/115VAC at full load				
	EFFICIENCY (Typ.)	94%	95%	95.5%	96%	
	AC CURRENT (Typ.)	10.1A/115VAC 5.3A/230VAC				
	INRUSH CURRENT (Typ.)	Cold start 20A/115VAC 40A/230VAC				
	LEAKAGE CURRENT	<0.75mA / 240VAC				
PROTECTION	OVERLOAD	105~120% rated output power Protection type: Constant current limiting with delay shutdown after 3 seconds, re-power on to recover				
	SHORT CIRCUIT	Protection type: Constant current limiting with delay shutdown after 3 seconds, re-power on to recover				
	OVER VOLTAGE	14.5 ~ 16V	29 ~ 33V	43.5 ~ 49V	59 ~ 66V	
	OVER TEMPERATURE	Protection type: Shut down O/P voltage, recovers automatically after temperature goes down				
FUNCTION	OUTPUT VOLTAGE PROGRAMMABLE(PV) Note.5	Adjustment of output voltage is allowable to 50 ~ 120% of nominal output voltage Please refer to the Function Manual.				
	OUTPUT CURRENT PROGRAMMABLE(PC) Note.5	Adjustment of constant current level is allowable to 20 ~ 100% of rated current. Please refer to the Function Manual.				
	REMOTE ON/OFF CONTROL	Power ON: "Low" <0 ~ 0.5V or Short circuit Power OFF: "Hi" >2 ~ 5V or Open circuit				
	AUXILIARY POWER	12V@0.5A tolerance±10%, ripple 150mVp-p				
	DC-OK SIGNAL	The TTL signal out, PSU turn on = 4.5 ~ 5.5V; PSU turn off = -0.1 ~ 0.5V. Please refer to the Function Manual.				
ENVIRONMENT	WORKING TEMP.	-30 ~ +70°C (Refer to "Derating Curve")				
	WORKING HUMIDITY	20 ~ 90% RH non-condensing				
	STORAGE TEMP., HUMIDITY	-40 ~ +85°C, 10 ~ 95% RH non-condensing				
	TEMP. COEFFICIENT	±0.03%/°C (0 ~ 50°C)				
	VIBRATION	10 ~ 500Hz, 5G 10min./1cycle, 60min. each along X, Y, Z axes				
SAFETY & EMC (Note.6)	SAFETY STANDARDS	UL62368-1, TUV BS EN/EN62368-1, EAC TP TC 004 approved				
	WITHSTAND VOLTAGE	I/P-O/P: 3.75KVAC I/P-FG: 2KVAC O/P-FG: 1.25KVAC				
	ISOLATION RESISTANCE	I/P-O/P, I/P-FG, O/P-FG: 100M Ohms/500VDC/25°C / 70%RH				
	EMC EMISSION	Parameter	Standard		Test Level / Note	
		Conducted	BS EN/EN55032 (CISPR32)		Class B	
		Radiated	BS EN/EN55032 (CISPR32)		Class B	
		Harmonic Current	BS EN/EN61000-3-2		Class A	
	Voltage Flicker	BS EN/EN61000-3-3		-----		
	EMC IMMUNITY	BS EN/EN55035, BS EN/EN61000-6-2				
		Parameter	Standard		Test Level / Note	
		ESD	BS EN/EN61000-4-2		Level 3, 8KV air ; Level 2, 4KV contact	
		Radiated	BS EN/EN61000-4-3		Level 3	
		EFT / Burst	BS EN/EN61000-4-4		Level 3	
Surge		BS EN/EN61000-6-2		2KV/Line-Line 4KV/Line-Earth		
Conducted		BS EN/EN61000-4-6		Level 3		
Magnetic Field		BS EN/EN61000-4-8		Level 4		
Voltage Dips and Interruptions	BS EN/EN61000-4-11		>95% dip 0.5 periods, 30% dip 25 periods, >95% interruptions 250 periods			
OTHERS	MTBF	662.3K hrs min. Telcordia SR-332 (Bellcore) ; 69.8K hrs min. MIL-HDBK-217F (25°C)				
	DIMENSION	240*115*41mm (L*W*H)				
	PACKING	1.74kg ; 8pcs/14.9kg/0.74CUFT				
NOTE	<ol style="list-style-type: none"> <li>All parameters NOT specially mentioned are measured at 230VAC input, rated load and 25°C of ambient temperature.</li> <li>Ripple &amp; noise are measured at 20MHz of bandwidth by using a 12" twisted pair-wire terminated with a 0.1uf &amp; 47uf parallel capacitor.</li> <li>Tolerance: includes set up tolerance, line regulation and load regulation.</li> <li>Derating may be needed under low input voltages. Please check the derating curve and Static characteristics for more details.</li> <li>PV/PC functions when users do not use SVR.</li> <li>The power supply is considered a component which will be installed into a final equipment. All the EMC tests are been executed by mounting the unit on a 360mm*360mm metal plate with 1mm of thickness. The final equipment must be re-confirmed that it still meets EMC directives. For guidance on how to perform these EMC tests, please refer to "EMI testing of component power supplies." (as available on <a href="http://www.meanwell.com">http://www.meanwell.com</a>)</li> <li>The ambient temperature derating of 3.5°C/1000m with fanless models and of 5°C/1000m with fan models for operating altitude higher than 2000m(6500ft).</li> </ol> <p>※ Product Liability Disclaimer : For detailed information, please refer to <a href="https://www.meanwell.com/serviceDisclaimer.aspx">https://www.meanwell.com/serviceDisclaimer.aspx</a></p>					

## ■ BLOCK DIAGRAM

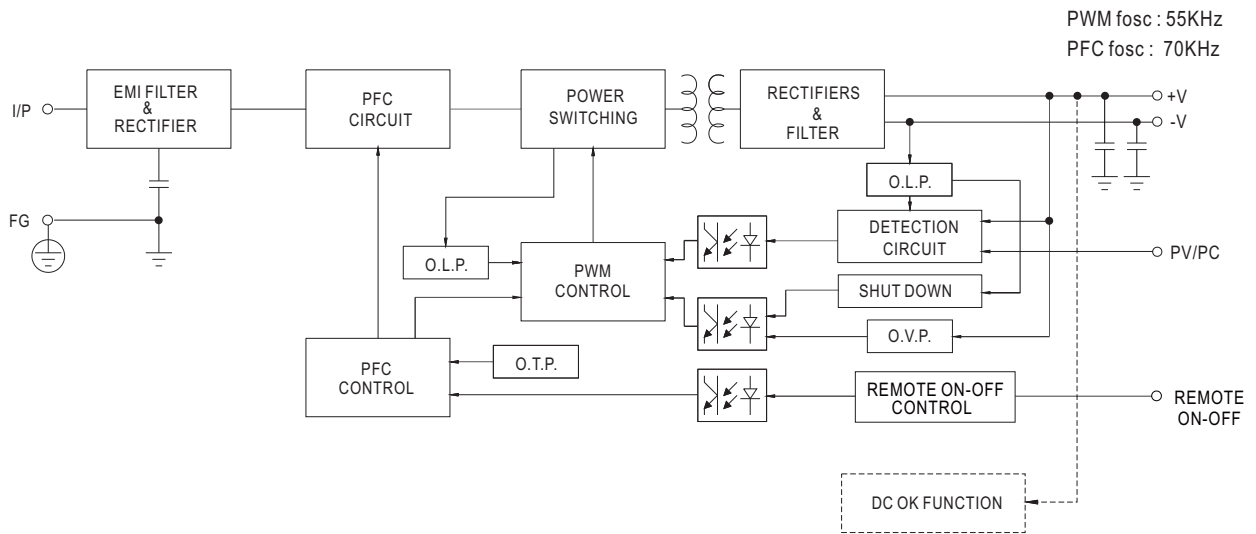

## ■ STATIC CHARACTERISTIC

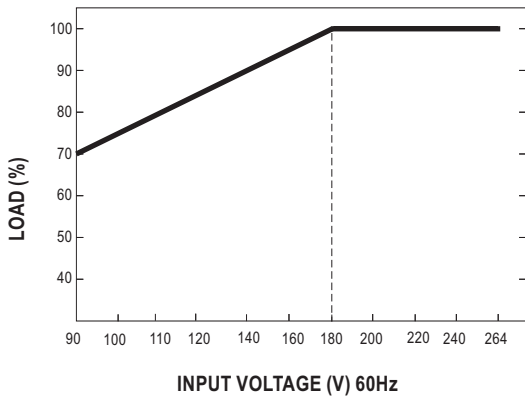

## ■ EFFICIENCY VS LOAD (48V MODEL)

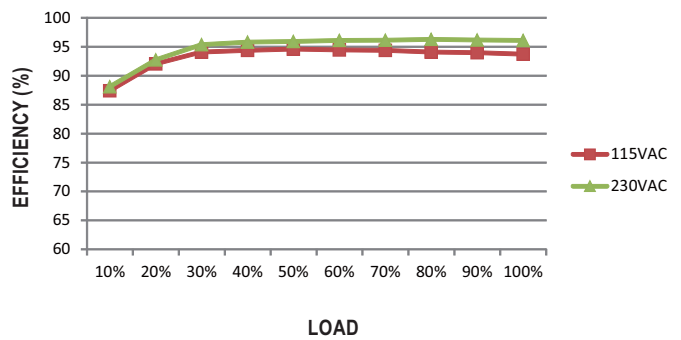

## ■ DERATING CURVE

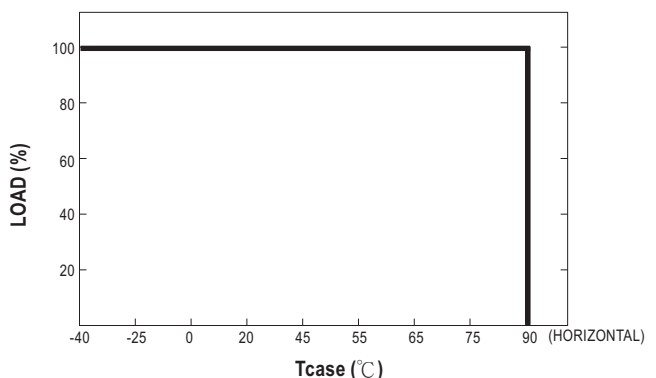
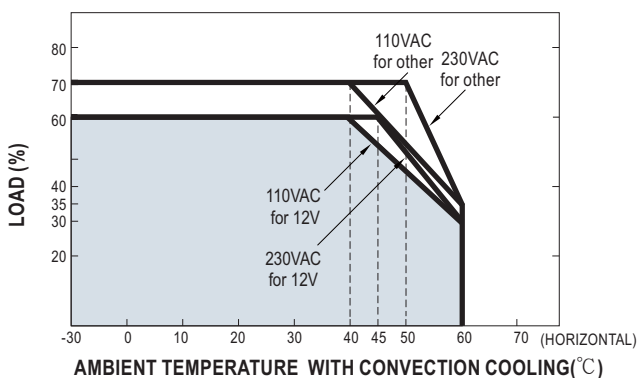
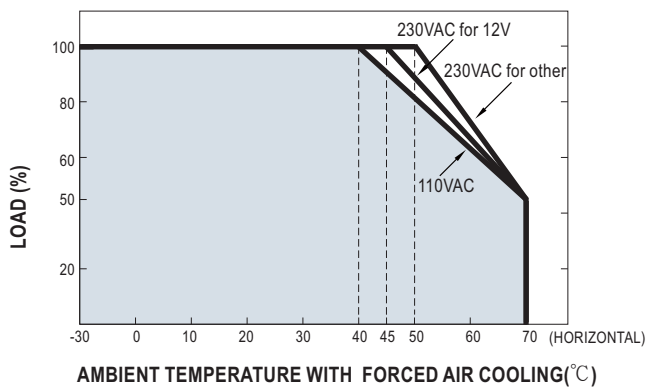
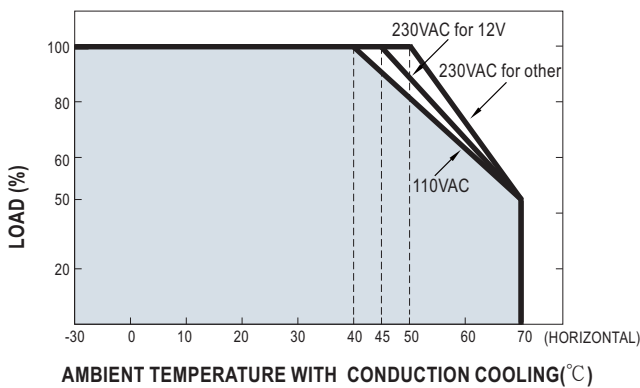

**FUNCTION MANUAL**

**1. Output Voltage Programming (or, PV / remote voltage programming / remote adjust / margin programming / dynamic voltage trim)**

※ In addition to the adjustment via the built-in potentiometer, the output voltage can be trimmed by applying EXTERNAL VOLTAGE.

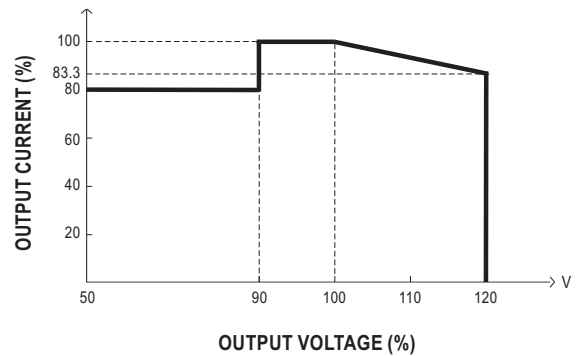
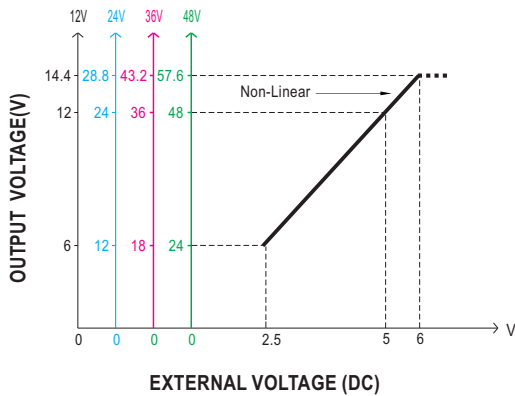
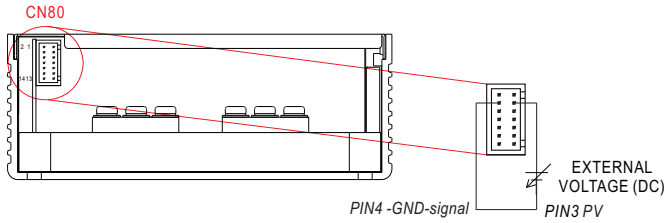

※ Caution: By factory default, the Output Voltage Programming is not activated, and PV (pin1) and PV-DIS(pin2) are shorted by connector. Whenever this function is not needed to activate, as assumed in other sections' diagrams, please keep PV (pin1) and PV-DIS(pin2) shorted ; otherwise the power supply will have no output.

※ Caution: When this function is needed to activate, please keep PV(pin1) and PV-DIS(pin2) opened.

**2. Output Current Programming (or, PC / remote current programming / dynamic current trim)**

※ The output current can be trimmed to 20~100% of the rated current by applying EXTERNAL VOLTAGE.

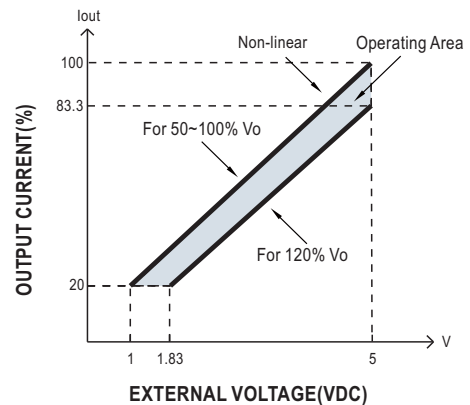
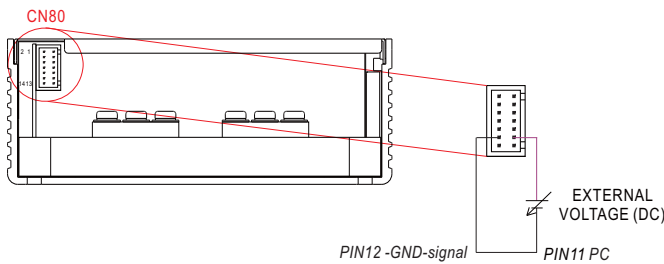

※ Caution: By factory default, the Output Current Programming is not activated, and VCCS(pin13) and PC-DIS(pin14) are shorted by connector. Whenever this function is not needed to activate, as assumed in other sections' diagrams, please keep VCCS(pin13) and PC-DIS(pin14) shorted ; otherwise, the power supply will have no output.

※ Caution: When this function is needed to activate, please keep VCCS(pin13) and PV-DIS(pin14) opened.

※ Covered by over temperature protection, auto de-rating function works under operation in PC mode .

T<sub>1</sub>(Typ.): Maximum ambient temperature of full load.

T<sub>2</sub>(Typ.): T<sub>1</sub>+5°C .

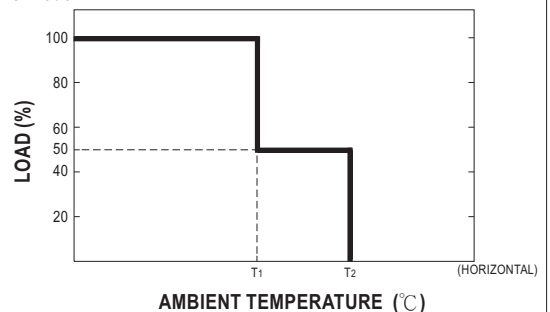

### 3. Remote ON-OFF Control

The power supply can be turned ON/OFF individually or along with other units in parallel by using the "Remote ON-OFF" function.

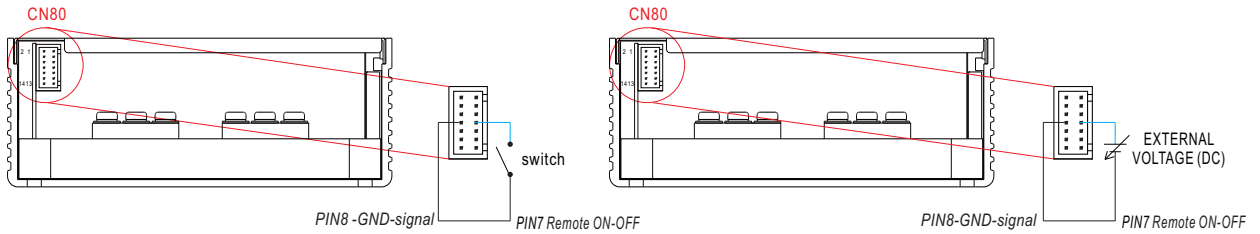

Remote ON-OFF	Power Supply Status
"Low" <0~0.5V or Short circuit	ON
"Hi" >2~5V or Open circuit	OFF

### 4. DC-OK Signal

DC-OK signal is a TTL level signal. The maximum sink current is 10mA and the maximum external voltage is 5.6V.

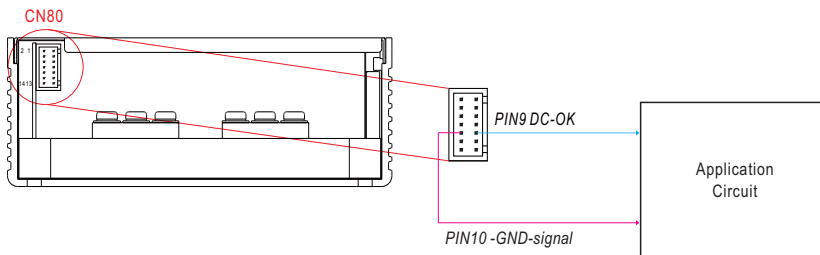

DC-OK signal	Power Supply Status
"Hi" >4.5~5.5V	ON
"Low" <-0.1~0.5V	OFF

**MECHANICAL SPECIFICATION**

Case No.:272A Unit:mm

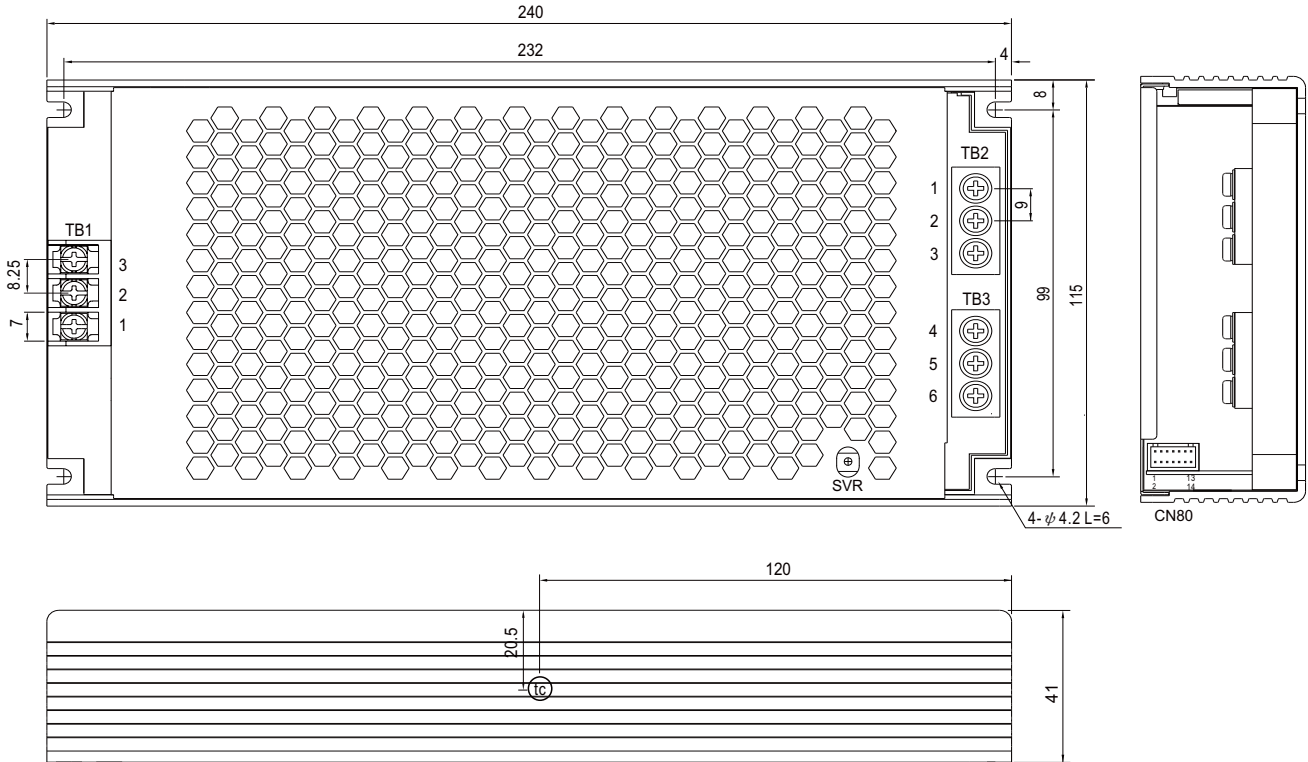

• (tc) : Max. Case Temperature

AC Input Terminal(TB1) Pin NO. Assignment

Pin No.	Assignment	Terminal	Max mounting torque
1	AC/L	DECA T42-ES11-03	13.8Kgf-cm
2	AC/N		
3	⊥		

DC Output Terminal (TB2,TB3) Pin NO. Assignment

Pin No.	Assignment	Terminal	Max mounting torque
1,2,3	+V	(MW)	8Kgf-cm
4,5,6	-V	NEL-400	

※Control Pin No. Assignment(CN80): HRS DF11-14DP-2DS or equivalent

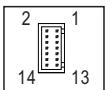

Mating Housing	HRS DF11-14DS or equivalent
Terminal	HRS DF11-14SC or equivalent

Pin No.	Function	Description
1,3	PV	Connection for output voltage programming.
2	PV-DIS	Short connecting between PV (pin1) and PV-DIS (pin2) if output voltage programming function is not activated.
4,8,10,12	GND (Signal)	Negative output voltage signal.
5	+12V-AUX	Auxiliary voltage output, 10.8~13.2V, referenced to GND-AUX (pin6). The maximum load current is 0.5A. This output is not controlled by "Remote ON-OFF".
6	GND-AUX	Auxiliary voltage output GND. The signal return is isolated from the output terminals (+V & -V).
7	Remote ON-OFF	The unit can turn the output ON/OFF by electrical signal or dry contact between Remote ON/OFF. Short (0 ~ 0.5V): Power ON; Open (2 ~ 5V): Power OFF ; The maximum input voltage is 5.5V.
9	DC-OK	Low (-0.1 ~ 0.5V): When the $V_{out} \leq 80\% \pm 5\%$ . High (4.5 ~ 5.5V): When $V_{out} \geq 80\% \pm 5\%$ . The maximum sink current is 10mA and only for output.
11	PC	Connection for constant current level programming.
13	Vccs	Positive output voltage signal.
14	PC-DIS	Short connecting between Vccs (pin13) and PC-DIS (pin14) if output current programming function is not activated.

**Operate with additional aluminum plate and fan**

In order to meet the "Derating Curve" and the "Static Characteristics", UHP-1000 series can be installed onto an aluminum plate (or the cabinet of the same size) on the bottom or apply forced air cooled solution. The size of the suggested aluminum plate and configuration of fan are shown as below. And for optimizing thermal performance, the aluminum plate must have an even and smooth surface (or coated with thermal grease), and UHP-1000 series must be firmly mounted at the center of the aluminum plate.

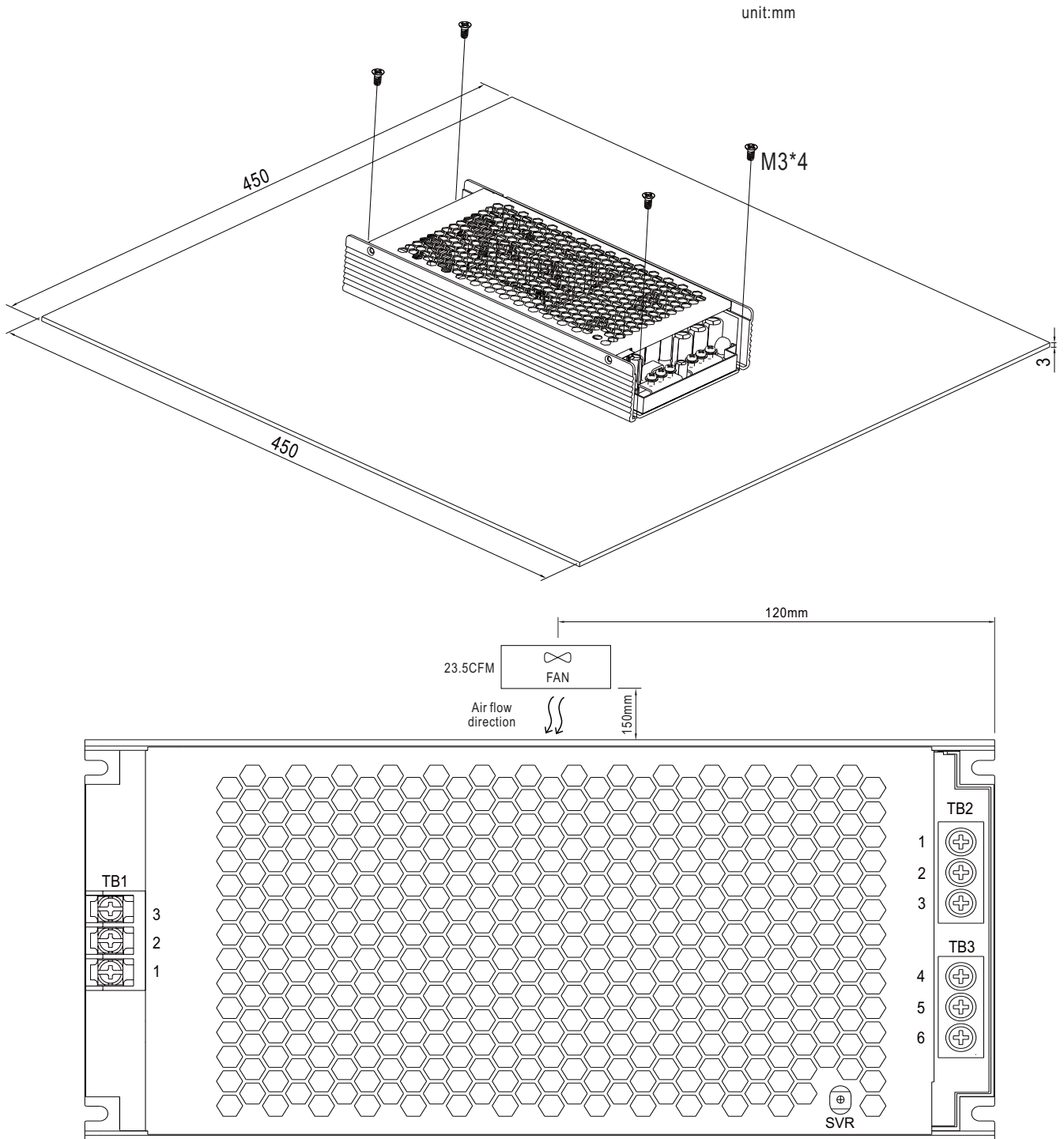

■ **INSTALLATION MANUAL**

Please refer to : <http://www.meanwell.com/manual.html>